

ski-doo 74

TNT

FC & EVEREST.

Owner's Manual

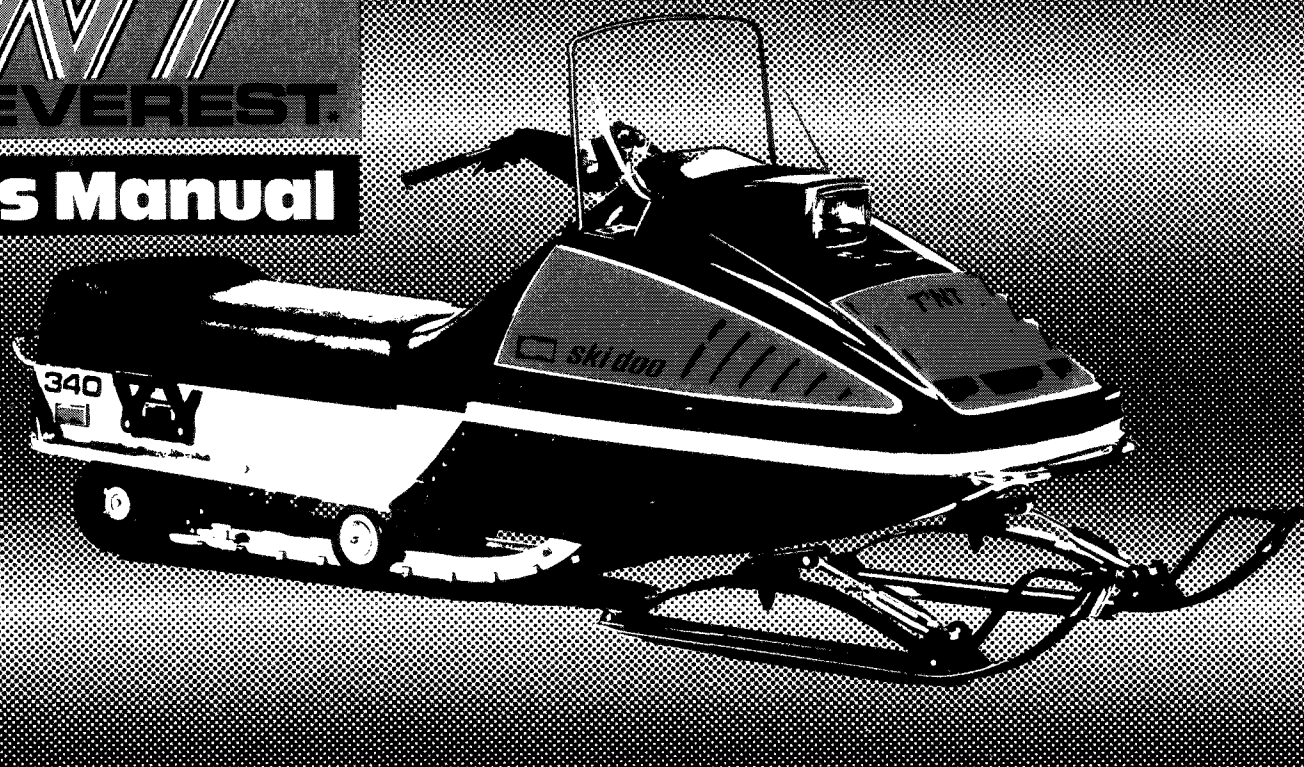

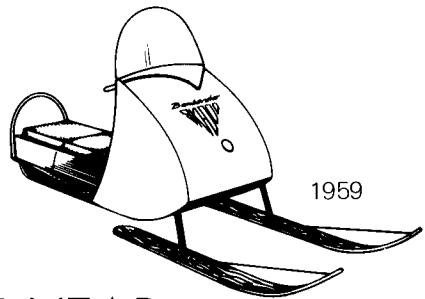

THE YEAR OF OUR MILLIONTH MACHINE

We wish J. Armand Bombardier could be around to see that millionth machine come off the production line this year. What would the inventor of the snowmobile think about today's jet-age styling? Or the incredible technical advances under the sleek cowl? We think he'd be amazed – and proud.

In this year of the millionth machine, J. Armand Bombardier would have a lot to be proud about. First of all, a million is an impressive number of machines. But there's something more important than quantity. The Ski-Doo* line-up of today reflects all the experience and know-how gained from the making of a million machines.

At Bombardier, we've had time to learn all the tricks of power and flotation. We've found out the pitfalls of operating an engine in freezing conditions over every conceivable winter terrain. And our experience shows. It shows in Ski-Doo* styling, performance and dependability.

Another thing our founder wouldn't recognize is the factory. From its start in a small garage, it's grown into the most advanced snowmobile factory in the world. Bombardier employs designers, engineers, specialists and craftsmen by the thousand. They put every Ski-Doo* through its paces, both in the versatile test laboratory, and on our outdoor speed track.

We've discovered that the best testing ground of all is the race track. We're in racing not only to win, but to learn. This year, we've been able to make some pretty impressive technical improvements to all our machines -- improvements made on the track to help you on the trail.

It adds up to a machine you can depend on, all the time. Your Ski-Doo* will give you excellent performance in all weathers, on all terrains. Look after it well, and it will serve you well. Your Ski-Doo dealer is always ready with information, parts and accessories. He is backed up by an international Ski-Doo distributor and Dealer network whose factory trained personnel are equipped to give you prompt and efficient service wherever you are in snow country.

Ride safe ... and have fun!

Laurent Beaudoin
President
Bombardier Limited

* Registered Trademark of Bombardier Limited

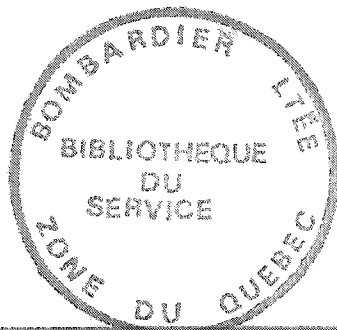

*This manual has been published by the
Technical Information Centre
Service Department
BOMBARDIER LIMITED
Valcourt, Quebec, Canada.*

INDEX

*The following are trademarks of Bombardier Limited.

| | | |
|-----------|-------------|------------|
| Ski-Doo | J'NT | Bombardier |
| Ski-Boose | Elan | Elite |
| Nordic | Blizzard | Everest |
| Alpine | Carry-Boose | |

PATENTS and DESIGNS

This vehicle is covered by one or more of the following patents and design registrations.

Canadian Patents: 605, 317 - 710, 592 - 724, 395 - 853, 505 - 895, 749 - 897, 747 - 914, 457 - 916, 204

United States Patents: 2,899, 242 - 3,066,546 - 3,536,153 - 3,637,254 - 3,666,323 - 3,673,884 - 3,693,884 - 3,693,992 - 3,704,918.

Canadian Designs: D1/217 F/28172 -D1/249 F/31317 and 316 -D32,479 - D32,535 - D32,655 to 657 - D32,661 to '669 - 33,982 -33,933 - 34,006 and '007.

United States Design Patents:

Des. 221,332 to '334-
Des 221,637 and '638-
Des. 222,244 to '247

Others: Swedish Design No. 6038-
Swiss Design No. 104,756-
Norwegian Design No. 51,444.

Other patent and design applications pending.

| | |
|--|-------------------|
| WHAT YOU SHOULD KNOW BEFORE FIRST RIDE..... | 2 |
| SERVICE AREAS | 3 |
| DO'S | 4 |
| DONT'S..... | 5 |
| GOOD DRIVING TECHNIQUE... .. | 6, 7 |
| CONTROLS / INSTRUMENTS..... | 8, 9 |
| FUEL MIXING | 10,11 |
| BREAK-IN PERIOD, PRE-START CHECK..... | 12,13 |
| IN CASE OF EMERGENCY..... | 13 |
| STARTING PROCEDURE | 14 |
| LUBRICATION | 15, 16 |
| MAINTENANCE 17, 18,19,20,21,22 | |
| EMERGENCY GUIDE..... | 23 |
| TROUBLE SHOOTING | 24, 25 |
| OFF SEASON STORAGE.. | 26, 27, 28 |
| PRE SEASON PREPARATION | 29 |
| SPECIFICATIONS | 30, 31 |
| WARRANTY | 32 |

All rights reserved © Bombardier Limited 1973



WHAT YOU SHOULD KNOW . . . before first ride.

To many of us, Winter is a revealing experience. Weather, atmospheric conditions, snow surfaces, individual driving habits and vehicle usage have considerable affects. We ask that you familiarize yourself with them . . . **read** the owner's manual; it has been prepared to acquaint you with the operation of your vehicle, its safety aspects and systems as well as preventative maintenance procedures that must be periodically upheld . . . all aimed toward a more enjoyable Winter season.

Observe the following precautions:

- Throttle mechanism should be checked for free movement **before** starting engine.
- Engine should be running **only when** pulley guard is secured in place.
- **Never** run engine without drive belt installed. Running an unloaded engine

can prove to be dangerous.

- **Never** run the engine at high R.P.M. when the tracks of the vehicle are raised off the ground.
- It can be dangerous to run engine with the **cab open**.
- Prolonged sitting while riding over rough terrain may cause kidney and/or spinal discomfort, specially for the driver or passenger having an existing back weakness.
- Gasoline is flammable and explosive under certain conditions. Always perform procedures in a well ventilated area. Do not smoke or allow open flames or sparks in the vicinity. If gasoline fumes are noticed while driving, the cause should be determined and corrected without delay.
- **Under no circumstances** should you wear loose clothing or scarves that could become entangled with moving

parts of your snowmobile.

- Your snowmobile **is not** designed to be operated on public streets, road or highways. In most States and Provinces, it is considered an **illegal** operation.
 - Hidden telephone guy wires or roadside ditches can cause serious **accidents**.
 - Your snowmobile **is not** designed to be driven or operated on black top, bare earth, or other abrasive surfaces. Abnormal and excessive wear of critical parts is inevitable.
 - **Always** wear an approved snowmobile safety helmet. Be informed on local laws legislating the sport.
 - Maintain your vehicle in top mechanical condition at all times.
- Please read and understand all other warnings contained elsewhere in this manual.**

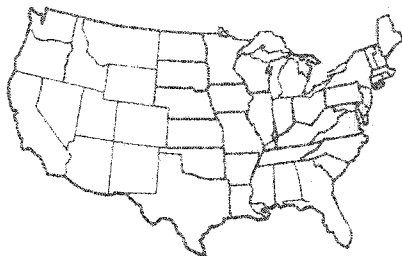

We recommend you contact your local Authorized Ski-Doo dealer when your Ski-Doo snowmobile requires service. However, for further inquiries you may contact your Regional Distributor listed below.

SERVICE AREAS

CANADIAN DISTRIBUTORS

| Name of Distributors | Coverage Area |
|---|---|
| ALPINE DISTRIBUTORS 3206 - 28th Ave., Vernon, B.C. | British Columbia |
| ATLANTIC SKI-DOO LTD. P.O. Box 670, Shediac, N.B. | Prince Edward Island Magdalen Island Nova Scotia New Brunswick |
| BOMBARDIER ONTARIO LTD. 28 Currie St., Barrie, Ont. | Ontario |
| BOMBARDIER QUE. LTD. 1350 Nobel St. Boucherville, Que. | Quebec |
| BROOKS EQUIPMENT LTD. Box 985, Winnipeg 21, Man. | Manitoba Saskatchewan |
| HUDSON'S BAY CO. 121 Richmond W., Toronto, Ont. | North-West Territories |
| J. W. RANDALL LTD. P.O. Box 757, Corner Brook, Newfoundland | Newfoundland |
| TRACT EQUIPMENT LTD. 14325 - 114th Ave., Edmonton, Alta. | Yukon Alberta |

AMERICAN DISTRIBUTORS

| Name of Distributors | Coverage Area |
|---|--|
| BOMBARDIER EAST INC. Railroad St., Lee, Massachusetts 01238 | Massachusetts Connecticut Rhode Island |
| BOMBARDIER WEST INC. 609 West Broadway, Idaho Falls, Idaho 83401 | California Nevada Montana Idaho Wyoming Utah Colorado |
| CRAIG TAYLOR EQUIPMENT CO. P.O. Box 3338, Anchorage, Alaska 99501 | Alaska |
| ELLIOTT & HUTCHINS INC. East Main Street Road, Malone, New York 12953 | New York Pennsylvania New Jersey Maryland Delaware District of Columbia Virginia |

HALVORSON INCORPORATED
325 South Lake Avenue,
Duluth 2, Minn. 55802

North Dakota
South Dakota
Minnesota
Wisconsin
Iowa
Illinois
Missouri
Upper Michigan

HEATH INTERNATIONAL INC.
33737 - 32 Mile Road,
Richmond, Mich. 48062

Lower Michigan
Indiana
Ohio
Tennessee
Kentucky
W. Virginia

TIMBERLAND MACHINES INC.
10 Main St. North, Lancaster,
New Hampshire 03584

Maine
New Hampshire
Vermont

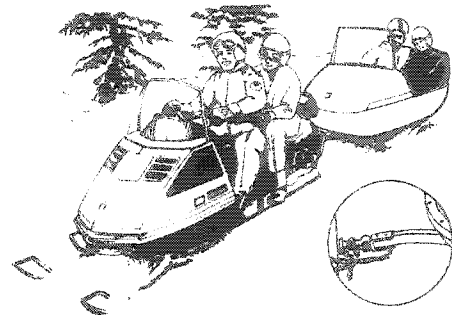
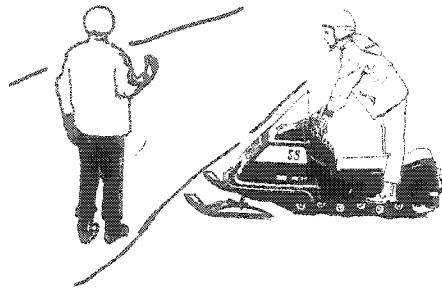

DO'S

- Register your Ski-Doo snowmobile at your nearest Licensing Bureau, where State or Provincial Laws require it, and affix registration to the vehicle. Carry your registration certificate with you. It provides proof of ownership in the event that the vehicle becomes lost or stolen.
- Obtain your State or Provincial booklet on snowmobiling. It gives valuable information on the neighbouring snowmobile trails and the laws governing snowmobiling in your particular area.
- Observe all posted snowmobile signs. Not all private landowners allow snowmobiling on their property. You can have just as much fun, even more so, by traveling elsewhere.

- When with others, limit your actions to the experience of the main body. Show the inexperienced driver how to properly handle a snowmobile.
- Always travel with at least one other snowmobile, especially in unfamiliar terrain or on trail rides. Even in snowmobiling, a pair beats one of a kind.
- If you are planning to explore new areas, leave word of your approximate whereabouts and estimated time of return with someone.
- Always make a full stop then look carefully in both directions before crossing roads. When traveling in pairs or in a group, have one member direct the others across singly.

- Use a rigid hitch or tow-bar when pulling any sled or trailer behind your Ski-Doo snowmobile. Rigid hitches prevent tailgate collision when going downhill or on sudden stops.
- Be extremely careful when giving children a ride. Go more slowly and check frequently. Small children, are far safer in a Ski-Boose* sled than on the seat of your snowmobile.
- When trailering your Ski-Doo snowmobile, secure it solidly at both ends, protect it with a bright cover (Ski-Doo* cover) then check that trailer hitch and safety chain are secure and that brake, flashers, position and parking lights are all in working order.

*Trademark: Bombardier Limited

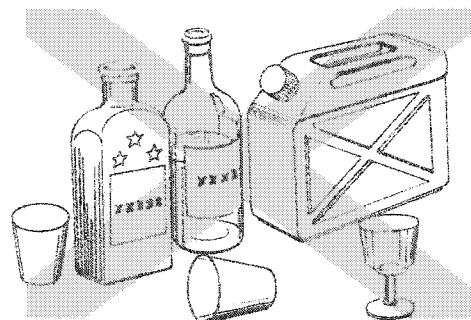
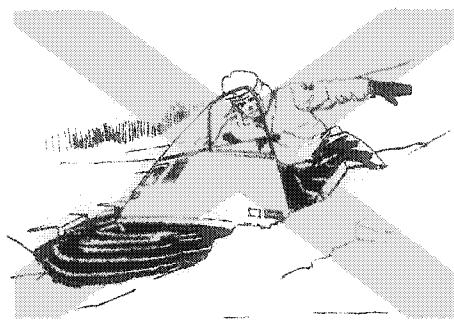
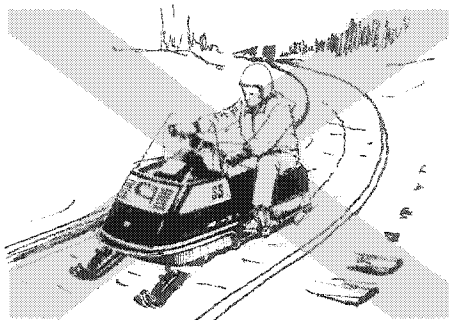

DON'TS

- Don't cut across in front of the line of travel of another snowmobile. Don't tailgate; collision, or the threat of it, is serious with any moving vehicle.
- Don't risk injury or damage to your machine with needless and foolish stunting. Don't "jump" your snowmobile. This part of snowmobiling should be left to the professional "stunt" men.
- **Never** ride on railway tracks. The sound of your moving vehicle drowns out noise of approaching trains. Your vehicle may also become caught in track junctions. In many States and Provinces snowmobiling on railway tracks constitutes an infraction of the law.
- Never cut through fences or attempt to run over them.

- Don't cross a river or lake without first being positive that the thickness of the ice is sufficient to support both you and your vehicle. **Your life may depend on it.** If at all in doubt, take an alternate route.
- Unless you are certain of a fueling stop, never travel further than 1/2 of the fuel remaining in your tank. Even then, leave yourself a safety margin. Remember that a snowmobile does not necessarily travel the same distance each time on the same amount of fuel. A lot depends on speed, snow conditions of the trail and adjustment of the carburetor.
- Don't drive your snowmobile in the vicinity of skiers and keep off ski trails. Always respect the rights of those who enjoy winter in another way.

- **"If you drink don't snowmobile! If you snowmobile, don't drink!"** Remember alcohol and gasoline don't mix.
- Don't lend your snowmobile to inexperienced or under-age drivers. In many cases it is the vehicle owner and not the rider that is responsible for mishaps. Check State or Provincial minimum age limits for drivers.
- Don't leave your keys in the ignition switch. It presents an invitation to thieves and a danger to children.
- Don't get hands or feet in track or moving parts. If your vehicle gets "bogged" down, stand to one side, squeeze the throttle lightly, lift the rear grab handle, and walk out the machine.

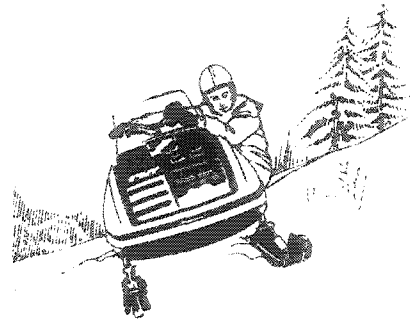
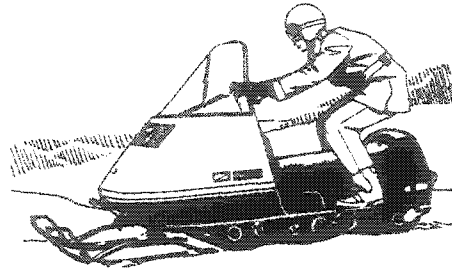
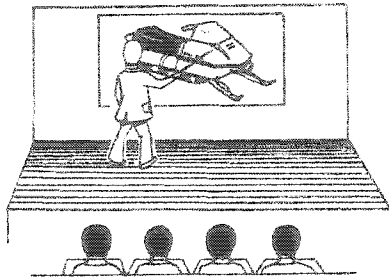

GOOD DRIVING TECHNIQUE

Everyone knows, or should know, the difference between a good snowmobiler and a poor one. Most beginners think that snowmobiling is just a matter of starting the engine and riding away. It's not so. There are right and wrong ways to go about it. Here are some of the preferred methods.

Tips

Where possible, enter a snowmobile training program. Thoroughly know your vehicle and how to drive it before attempting difficult or rapid maneuvers.

Driving Positions.

There are three driving positions on a snowmobile—Standing, Kneeling or Sitting. Each presents certain advantages depending on the nature of the terrain, snow conditions, the turns you desire or the personal preference of the driver.

Standing—This position is undoubtedly the best for climbing steep hills, traveling a short stretch of bumpy trail or when maneuvering in deep snow. In this position, however, always keep your knees slightly flexed to absorb surface shocks.

Kneeling—crossing a steep slope, for example, from side to side, you will find the kneeling position a definite advantage. Place one foot on the footboard (on the high side of the hill), the opposite knee on the seat then lean into the hill.

Warning: Side hills and steep slopes are not recommended for a beginner.

An alternate recommended kneeling position and one that is frequently used, is to place both knees on the seat, with one foot on each side, loosely pressing against the seat.

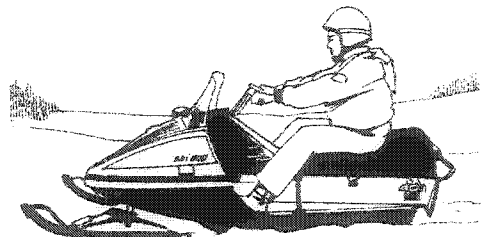
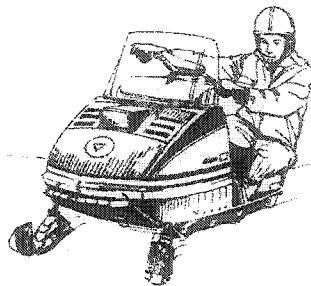
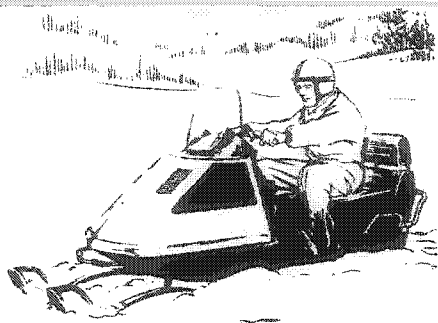

Sitting—for all normal driving. Feet should be on the footboards, body mid-way back on the seat. **Avoid** placing your foot inside the support braces of the footboard.

Warning: Prolonged sitting while riding over rough terrain may cause kidney and/or spinal discomfort, specially for the driver or passenger having an existing back weakness.

Turning.

To snowmobile properly you must learn to "body english", (using the weight or position of your body). Shifting to left or right as the turn demands and keeping your center of gravity as low as possible will give you the mark of an experienced snowmobiler.

Moving your body weight toward the front of the vehicle, particularly in hard-packed snow, adds pressure to the skis and ski runners so that they bite more deeply into the snow surface.

Icy Surface.

Ice or extremely hard-packed snow can be difficult to negotiate as both skis and track do not have much traction. Best advice is to slow down and avoid rapid acceleration or braking.

Deep Snow.

Use the standing position recommended earlier and if your vehicle continues to make reasonable headway, responding to light changes in acceleration, you are safe enough to explore new areas. If not, turn in as wide an arc as possible and look for firmer trails.

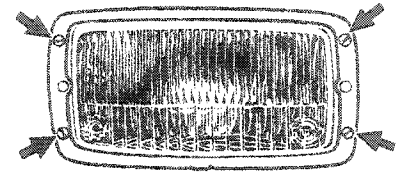
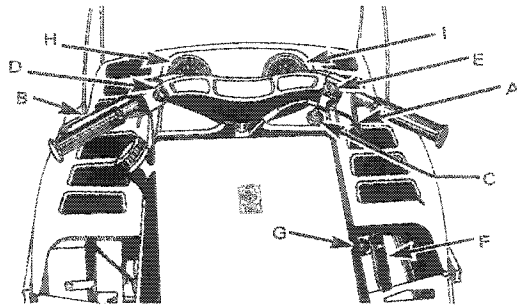

CONTROLS/INSTRUMENTS

Steering

Rotation of the handlebar causes a push-pull action on the steering linkage and forces the skis to turn in the required direction. Incorporated in the crash padded handlebar are the dimmer switch, cut-out button, brake and throttle levers.

Throttle Lever (A)

Located on right side of handlebar. When depressed, the lever controls the **engine speed** and the **engagement of the transmission**. When lever is released the engine speed returns automatically to **idle**.

Brake Lever (B)

Located on the left side of handlebar. When lever is depressed, the brake is applied. When released, it automatically returns to its original position. Braking effect is proportionate to the pressure applied on the lever.

Ignition/Lights Switch (C)

Key operated, 3 position switch (OFF/ON/LIGHTS). To start engine, first turn key clockwise to ON position. To stop engine, turn key counter-clockwise to OFF position. Turning key fully clockwise, with engine running, illuminates both headlamp and taillight.

Ignition/Lights Switch

(Electric Models only)

Key operated, 4 position switch (OFF/LIGHTS/ON/START). To start engine, turn key fully clockwise to START position and hold. Return key to ON position **immediately** engine has started. To illuminate both headlamp and taillight turn key to LIGHTS position.

Headlamp Dimmer Switch (D)

The dimmer switch, located on left side of handlebar, allows correct selection of headlamp beam. To obtain Hi or Low beam simply depress switch.

Note: The angle of the headlamp beam had been pre-adjusted prior to delivery. Should you wish readjustment, remove headlamp chrome ring and turn upper or lower adjusting screws to obtain desired beam position.

Cut-out Button (E)

A push button switch located on right side of handlebar. To stop the engine, press button down into **lower** position. Before re-starting engine always depress button into released **upper** position. The driver of this vehicle should familiarize himself with the function of this device by using it several times on first outing, thereby being mentally prepared for emer-

Upper position
before starting
engine.

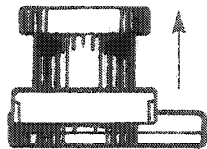

Lower position
to stop engine.

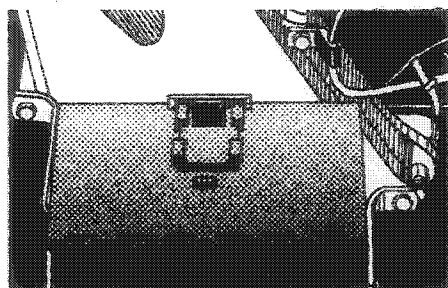
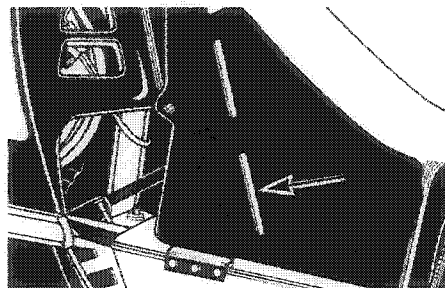
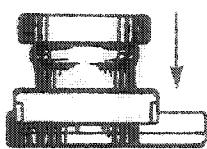

gency situations requiring its use.

Warning: If the button has been used in an emergency situation the source of malfunction should be determined and corrected before restarting engine.

Manual Starter (F)

Auto-rewind type located at right side of console in cab recess. To start engine, pull handle. (See Starting Procedure).

Choke (G)

A push-pull button located alongside manual starter handle. Pull button to engage choke, push to disengage. The choke should always be used for easier cold engine starts. After engine is warmed up, however, it is not necessary to use choke when starting.

Note: The purpose of the choke is to reduce the amount of air flowing through the carburetor, in effect enriching the

air/fuel mixture. **Always** push choke knob to off, once engine has started. **Never** operate your vehicle with choke on.

Tachometer (H) (Except 300 SM model)

The tachometer registers the impulses of the magneto. Direct-reading dial indicates, in thousands, the number of revolutions per minute (R.P.M.) of the engine.

Speedometer (I) (Except 300 SM model)

The speedometer is linked directly to the drive axle. Direct-reading dial indicates the speed of the vehicle in miles per hour (M.P.H.). Odometer records the total number of miles travelled. On the 440 SM, 440 SE and Everest 440 SM models, a trip odometer is standard equipment. To reset, turn knob counter-clockwise.

Fuel Level

Fuel level can be quickly checked by

glancing at side of fuel tank. However, for accurate reading, unscrew gas tank cap and withdraw dipstick from tank.

Cab Latches

For those procedures that require cab open, unlock latches on both sides where cab meets frame then lift cab gently up until stopped by restraining device.

Warning: It can be dangerous to run engine with cab open.

Tool box

Located under the cab, alongside the chaincase. Ideal location for spare spark plugs, drive belt, rope, etc.

Tips

Emergency items should be wrapped in foam or similar material. This will prevent possible breakage while traveling over rough or bumpy terrain.

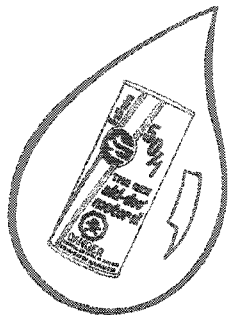
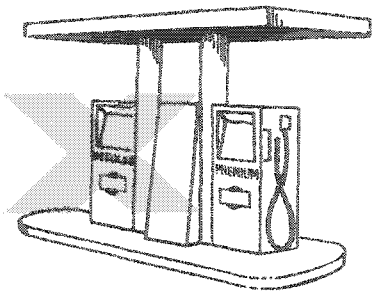

50/1

FUEL MIXING

With Ski-Doo snowmobiles, the **oil** must be added to the **gasoline** in pre-measured amounts then both oil and gasoline should be thoroughly mixed together **before** fueling the tank.

Which Gasoline to Use

On all models the correct gasoline is **Premium** gasoline (not less than 98 octane) available from all service stations.

Caution: Never experiment with different fuel or fuel ratios. Never use regular or no lead gasoline,† naphta, methanol or similar products.

† Tests are not conclusive enough therefore we do not recommend the use of no-lead gasolines.

Which Oil to Use

Use **concentrated** Ski-Doo oil available from your Ski-Doo dealer. This type of oil has specially formulated oil bases to meet the lubrication requirements of the Bombardier-Rotax engine.

Caution: The carburetors of the 1974 Ski-Doo snowmobile have been calibrated for a mixture of gasoline and concentrated Ski-Doo oil. Unless absolutely necessary, do not use regular snowmobile oil. If such oil is used, observe mixing instructions on the container. Never use out-board or straight mineral oils.

Fuel Mixing Ratio

The importance of using the correct fuel mixture cannot be overstressed. Prior experience has shown that an incorrect fuel ratio results in serious engine damage.

Recommended fuel ratio is 50/1.

5 gallons recommended gasoline plus 1 can of 50/1 Ski-Doo concentrated oil = correct fuel mixture.

Note: To facilitate fuel mixing, oil should be kept at room temperature.

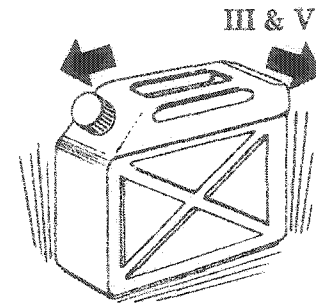
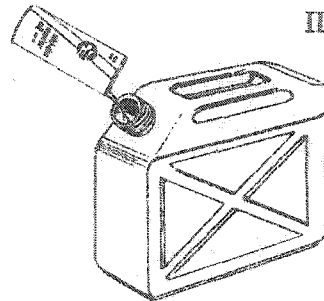
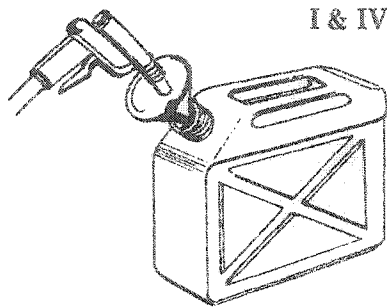

FUEL MIXING

Fuel Mixing Procedure

To mix the gasoline and oil always use a separate clean container. Never mix directly in your snowmobile tank. For best results, acquire two containers, either plastic or metal. Draw from one until empty then use the second one.

Warning: Gasoline is flammable and explosive under certain conditions. Always perform procedures in a well ventilated area. Do not smoke or allow open flames or sparks in the vicinity. If gasoline fumes are noticed while driving, the cause should be determined and corrected without delay. Never add fuel while engine is running.

1. Pour approximately one gallon of gasoline into a clean container.
2. Add the full amount of concentrated Ski-Doo oil.
3. Shake the container thoroughly.
4. Add the remainder of the gasoline.
5. Once again thoroughly agitate the container. Using a funnel with a fine mesh screen to prevent the entry of water and foreign particles, transfer mixture from container into the snowmobile tank.

Note: When using pre-mixed fuel, always shake the container thoroughly as the oil has a tendency to settle.

Warning: Never 'top up' gas tank before placing vehicle in a warm area. At certain temperatures, gasoline will expand and overflow.

Fuel consumption

A good idea is for you to rate the fuel consumption of your snowmobile at the first opportunity. Starting with a full fuel tank, mark the time of your departure then note time elapsed until tank is half-full. Repeat on different occasions to get a mean average of your snowmobiles' consumption and length of running time under varying conditions.

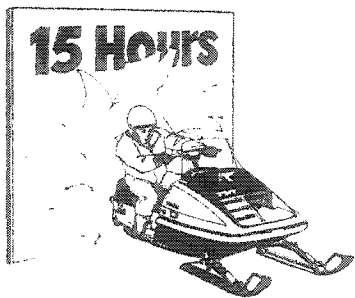

BREAK-IN PERIOD

With Ski-Doo snowmobile engines, a break-in period is required **before** running the vehicle at full throttle. Manufacturer's recommendation for the Bombardier-Rotax engine is 10 to 15 operating hours. During this period, maximum throttle should not exceed $\frac{3}{4}$. However, brief full accelerations and speed variations contribute to a good break-in. Continued wide open throttle accelerations, prolonged "cruising" speeds and lugging are detrimental during the break-in period.

Inspection

After the break-in period, we suggest that each Ski-Doo snowmobile has an inspection check. This inspection is at the discretion and expense of the vehicle owner.

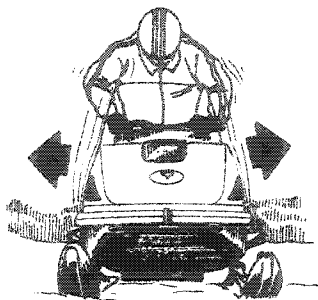

PRE-START CHECK

Fuel Tank Quantity

Check that there is sufficient fuel in the tank for your trip. A good habit to acquire is to refill the tank before starting out each day.

Since mixed fuel has a tendency to settle overnight, agitate the fuel in the tank by standing on the footboards and rocking the vehicle from side to side.

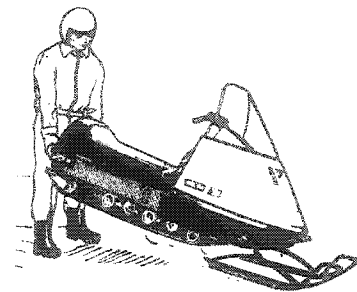

Track (Daily, before first run)

Under certain climatic conditions, the track of a snowmobile left outdoors overnight may freeze to the ground or snow surface. Always make sure that the track is free before attempting to start the vehicle. (This procedure will eliminate unnecessary drive belt wear).

Steering Operation

Check operation of steering mechanism by rotating the handlebar several times from side to side. If roughness or binding is felt, check for ice or snow that may be blocking the mechanism.

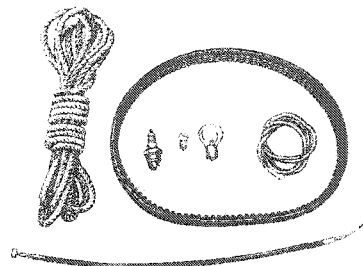
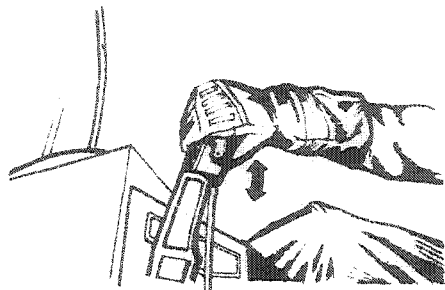

IN CASE OF EMERGENCY

Throttle and Brake

Depress throttle lever several times to check that it operates easily and smoothly. The throttle lever should return to the idle position when released. If the lever does not return swiftly, remove cable and housing and replace. Re-check lever operation. Brake leverage is correct when the lever has 1/2" approx. clearance from handlebar grip when fully applied.

Warning: Throttle mechanism should be checked for free movement before starting engine. Once all components are checked and functioning properly, you can start your Ski-Doo snowmobile.

Emergency situations are accepted hazards with any moving vehicle. A hidden rock or stump on the trail, a burnt light bulb while driving at night, an empty fuel tank while miles from anywhere, can all cause varying degrees of inconvenience. Unlike an automobile, which has a distinct advantage in that service stations are usually within walking distance, **snowmobiles are specifically designed to travel off the highways.** When the unexpected happens, the driver often has only his own ingenuity and that of his companions to return home safely. Fortunately, 9 out of 10 difficulties encountered on the trail can be fixed on the spot. However, you must carry at least a minimum assortment of Tools and Spare Parts to enable you to effect minor repairs.

Emergency Materials

In addition to those tools which the manufacturer provides, you should carry the following:

Tools: General Purpose Pliers—Adjustable Wrench (3/4" opening)—Flashlight.

Spare Parts: Spark Plugs—Drive belt—Headlamp and Taillight bulbs—Throttle Cable and Housing—Starting and towing rope — Fuse (electric models).

Important: Always carry spare plugs and drive belt. Check condition of spark plug frequently and look for signs of a fouled or defective plug.

Upper position
before starting
engine.

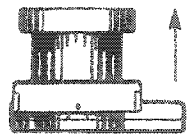

Lower position
to stop engine.

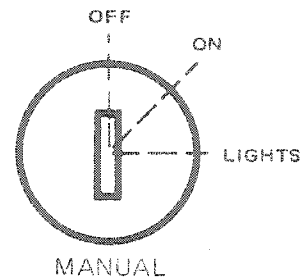
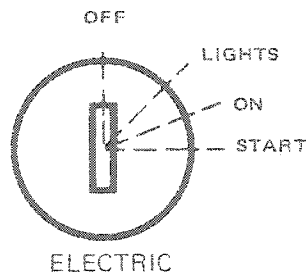
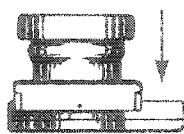

STARTING PROCEDURE

Warning: Never run the engine at high RPM when the track of the vehicle is raised off the ground.

Note: Before starting the engine make sure the cut-out button is in the released upper position.

Electric Starting:

1. Insert key in ignition switch.
2. Engage choke. (Choke is not necessary if engine is warmed up).
3. Test throttle operation then apply throttle lever slightly.
4. Turn ignition key clockwise until starter engages.

Caution: Do not engage starter longer than 30 seconds. If engine does not start on first try, key must be turned fully back to OFF each time. Allow starter to

cool for 2 minutes before repeating procedure.

5. **Release** throttle and key **immediately** engine has started.
6. Disengage choke.

Caution: Never operate the Ski-Doo snowmobile with the battery removed or disconnected.

7. Allow the engine to warm up before operating at full throttle.

Manual Starting:

1. Insert key in ignition and turn to ON position.
2. Engage choke. (Choke is not necessary if engine is warmed up).
3. Test throttle operation then apply throttle lever slightly.

4. Grasp manual starter handle firmly and pull slowly until a resistance is felt then pull virously and engine will start. Allow handle to return **slowly** to its original position. If engine does not start, repeat the procedure.

Note: Do not pull starting rope to its fullest extent or allow starting handle to "fly back" to its original position.

5. **Release** throttle, disengage choke, **immediately** engine has started.

6. Allow the engine to warm up before operating at full throttle.

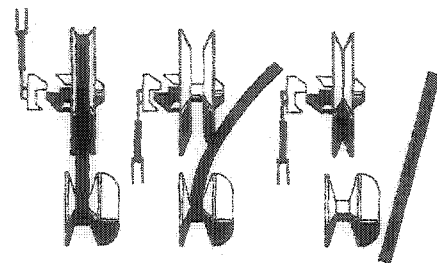
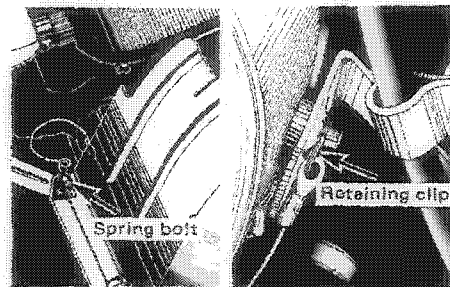
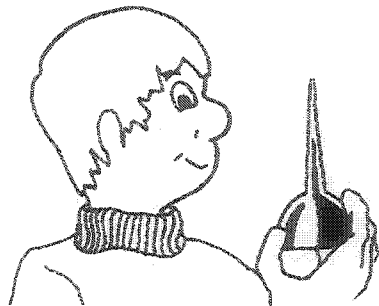

LUBRICATION

Frequency of Lubrication

It is recommended that the steering system and suspension, be lubricated monthly or every 40 hours of operation. If the vehicle is operated in wet snow or in severe conditions, these items should be lubricated more frequently.

Caution: The driven pulley does not require lubrication, however, clearing is necessary during storage.

Pulley guard

1. Tilt cab, pull out retaining clip and disengage stud from bracket. Tilt guard forward.
2. To remove completely from vehicle, once guard stud is disengaged from rear bracket, pull out front retaining clip and pull on spring bolt to disengage pin from front bracket.

Warning: Engine should be running only when pulley guard is secured in place and cab is closed.

Drive Belt Removal

1. Tilt cab and pulley guard. Unlock and raise driven pulley support.
2. Open the driven pulley (larger pulley), by twisting and pushing the sliding half. Hold in open position.
3. Pull the belt in toward the center of the driven pulley then slip slackened belt over the top edge of pulley.
4. Slip the belt from the drive pulley.
(To install, follow reverse procedure).

Warning: Never start or run engine without drive belt installed.

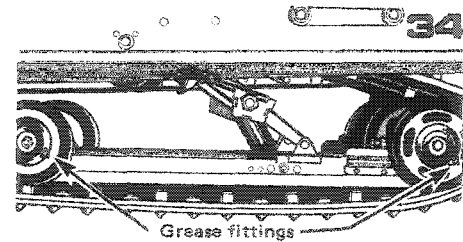
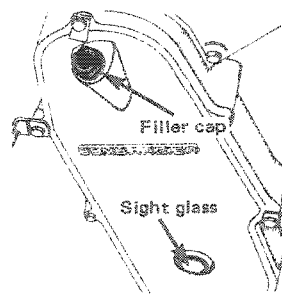
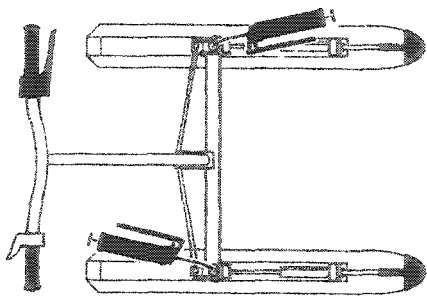

Steering Mechanism

Oil spring coupler bolts. Lubricate ski legs at grease fittings until new grease appears at joints.

Chaincase Oil Level

Remove tool box then check oil level through sight glass of chaincase. Level should not be below the sight glass line. The chaincase has an oil capacity of approximately 9 oz. To replenish, remove filler cap using spark plug wrench. Refill to level line.

Suspension

Lubricate the five (5) idler wheels with low-temp. grease, using a low pressure Grease gun. (Pump 3 to 4 times through the grease fitting, located on each cap of idler wheel). Wipe off excess.

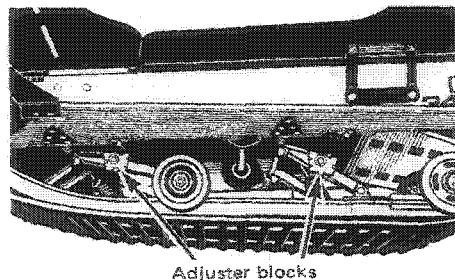
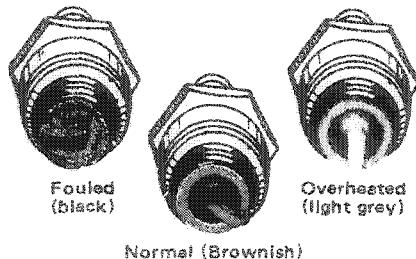

MAINTENANCE

| Code | Weekly | Page |
|------|-----------------------|------|
| W1 | Spark Plugs | 17 |
| W2 | Suspension Springs | 17 |
| W3 | Suspension Adjustment | 17 |
| W4 | Track | 18 |
| W5 | Track Tension | 18 |
| W6 | Track Alignment | 18 |
| W7 | Battery | 18 |
| W8 | Carburetor Adjustment | 19 |
| W9 | Drive Belt Condition | 20 |

| Code | Monthly | Page |
|------|----------------------------|------|
| M1 | Carburetor Flange Nuts | 20 |
| M2 | Brake | 20 |
| M3 | Steering Adjustment | 21 |
| M4 | Engine Head Nuts | 22 |
| M5 | Engine Mount Nuts | 22 |
| M6 | Slider Shoe Wear | 22 |
| M7 | Vehicle General Inspection | 22 |

(W1) Spark Plugs

1. Disconnect spark plug wires and remove spark plugs.
2. Check condition of plugs.

- A brownish tip reflects ideal conditions. (Correct carburetor adjustment, spark plug heat range; etc.).
- A black insulator tip indicates fouling caused by: carburetor idle speed mixture and/or high speed mixture-too rich, incorrect fuel mixing ratio, wrong type of spark plug (heat range), or excessive idling.
- A light grey insulator tip indicates a lean mixture caused by: carburetor high speed mixture adjusted too lean, wrong spark plug heat range, incorrect fuel mixing ratio, or a leaking seal or gasket.

Caution: If, when checking spark plug color, you find that the engine is not running under ideal conditions, contact your authorized Ski-Doo dealer.

3. Reinstall plugs and connect wires.

W2 Suspension Springs

With engine **off**, visually inspect suspension springs. Replace any weak or broken spring.

W3 Suspension Adjustment

The suspension is adjustable, the front adjustment for surface condition, the rear for driver's weight. The front adjuster blocks should be positioned at the lowest elevation for deep snow conditions. A higher elevation is preferred when negotiating icy snow. The rear adjuster blocks should be adjusted until a distance of 4 1/2" to 5 1/2" is obtained between rear

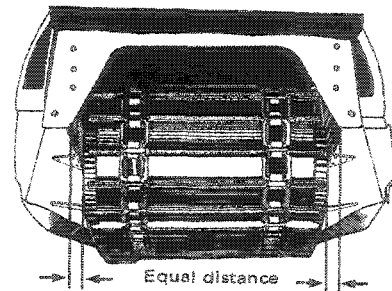
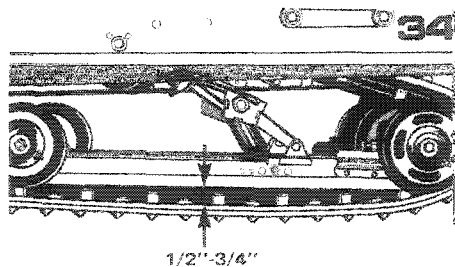

of footrest and ground when the driver is seated on the vehicle. (The spark plug wrench is an ideal tool).

Caution: Always turn left side adjuster blocks in a clockwise direction, the right side blocks in a counter-clockwise direction. Left and right adjuster blocks of each adjustment must always be set at the same elevation.

(W4) Track

Lift the rear of the vehicle and support it off the ground so that the track is free to turn. With engine **off**, rotate track by hand and visually inspect track condition.

(W5) Track Tension

Lift rear of vehicle and support it off the ground. Allow slide to extend normally. A gap of 1/2" - 3/4" should exist between slider shoe and bottom inside of track.

If track tension is too loose, the track will have a tendency to thump. If too tight, performance will be affected. If necessary to adjust, loosen or tighten adjuster bolts located on inner side of rear idler wheels.

Note: Track tension and alignment are inter-related. Do not adjust one without the other.

(W6) Track Alignment

After track tension has been corrected start the engine and accelerate slightly so that track turns **slowly**. Check that track is well centered and turns evenly. To correct, loosen the lock nut and tighten the adjuster bolt on side where track is closest to the frame. Tighten lock nut and recheck alignment.

Warning: Before checking track alignment, ensure that the track is free of all particles which could be thrown out while track is rotating. Keep hands, feet and clothing clear of track.

(W7) Battery

Remove battery caps then check electrolyte level at each cell. Electrolyte level must touch bottom of filler hole. If necessary, add distilled water.

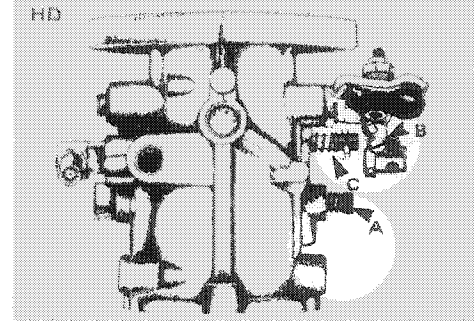
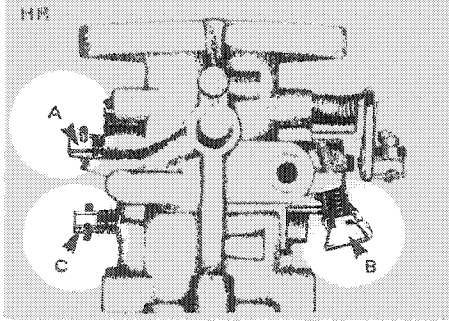

(W8) Carburetor Adjustment

The carburetor adjustments are: Maximum Throttle Opening, Low Speed Mixture, Idle Speed and High Speed Mixture.

Note: A relationship exists between each adjustment. Do not correct one without checking the other.

Maximum Throttle Opening

With engine **off** remove air silencer box from carburetor. Unscrew the idle speed adjusting screw until a gap exists between screw end and carburetor shaft lever. Adjust throttle cable so that the throttle butterfly is fully open when throttle lever gently touches handlebar grip. Install air silencer box.

Warning: Before starting engine, carburetor throttle lever must return to idle position (butterfly closed). Do not start engine unless this is verified.

Low Speed Mixture Adjustment (A)

A primary adjustment, with engine **off**, should be made by first turning Low Speed Mixture Screw fully clockwise until closed. Back off screw one (1) turn counterclockwise. (7/8 of a turn on 440 models).

Do not close screw too tightly as screw and/or screw seat can be damaged.)

For final adjustment, start engine and allow it to warm up. Turn Low Speed Mixture Screw until engine reaches maximum R.P.M. and obtain a steady idle and a fast response of engine to the throttle.

(Turning Low Speed Mixture Screw clockwise produce a leaner mixture, more air/less fuel; counter-clockwise, a richer mixture, less air/more fuel.)

Idle Speed Adjustment(B)

Turn the Idle Speed Adjusting Screw clockwise to increase idling speed, coun-

terclockwise to decrease.

High Speed Mixture Adjustment (C)

Warning: High Speed Mixture Adjustment must be carried out only by an authorized Ski-Doo dealer.

For primary adjustment however, with engine **off**, turn High Speed Mixture Adjusting Screw fully clockwise until it closes. Back off screw 1 turn counterclockwise. (Do not close screw too tightly as screw and/or screw seat can be damaged). Run the vehicle for at least one mile then check spark plug color. If brownish, carburetor setting is correct. If not, refer to spark plug condition.

Caution: Never operate your snowmobile with the air silencer box disconnected. Serious engine damage will occur if this notice is disregarded.

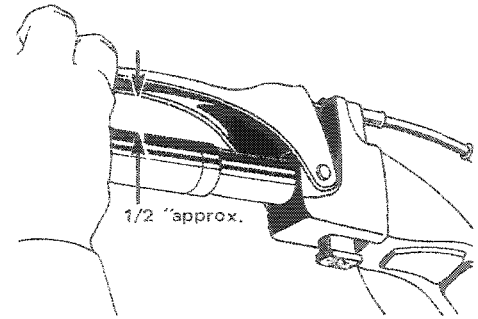
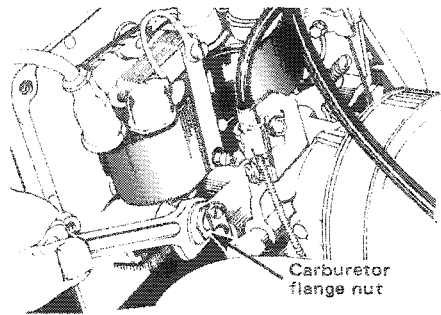

(W9) Drive Belt Condition

If belt is less than 1" wide, replace. Check condition of belt. Inspect for cracks, fraying or abnormal wear (uneven wear, wear on one side, etc.). If abnormal wear is noted, probable cause is pulley misalignment. Contact your dealer.

(M1) Carburetor Flange Nuts

After the first 2 hours of operation, check tightness of carburetor flange nuts. Open tab locks, tighten nuts and close tab locks.

Caution: The tab locks should be changed after being opened three times.

(M2) Brake

The brake mechanism on your snowmobile is an essential safety device. Keep this mechanism in proper working condition. Do not tamper with the brake. Above all, **do not operate your snowmobile without an effective brake system.**

Check operation of brake mechanism by depressing brake lever. Brake should apply fully when lever is 1/2" approx. from handlebar.

The brake mechanism is self-adjusting, therefore, periodic adjustment is not required. However, when changing a cable and/or housing the following should be observed.

1. Ensure that cable housing nuts are located approximately half way on housing threads.
2. Check brake operation.

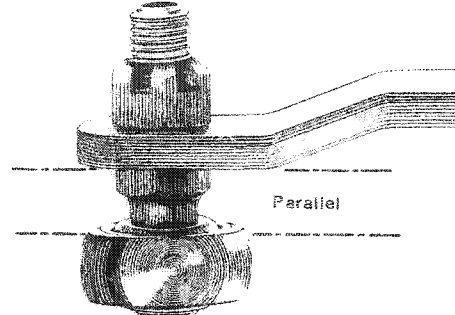
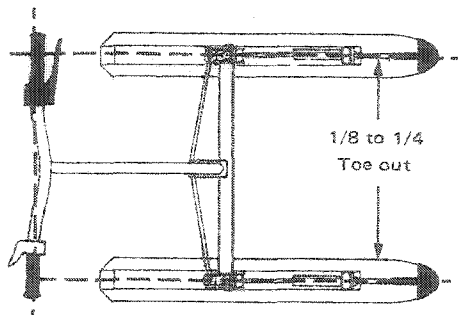
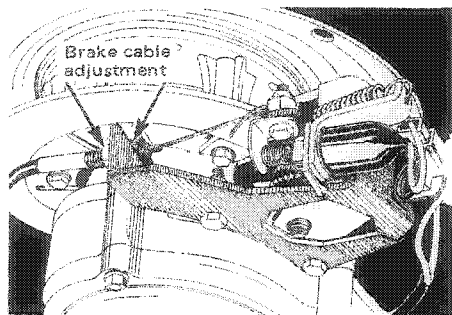

Note: Brake pucks less than 1/8" thick must be replaced. Always check the stop light to see if it functions after performing brake adjustment. If necessary, readjust brake housing.

(M3) Steering Adjustment

Skis should have a toe out of 1/8" to 1/4". To check, measure distance between each ski at front and rear of leaf springs. The front distance should be 1/8" to 1/4" more than the rear when the handlebar is horizontal. If adjustment is required:

1. Unscrew the nuts locking the tie rods in place.
2. Turn one or both tie rods until skis are parallel to each other. (Same distance between skis at front and rear).
3. Then, measuring at front of leaf springs, add an additional 1/16" to 1/8" on each side by rotating tie rod.
4. Tighten the nuts firmly against the tie rod. Check tightness of the steering arm locking bolts. (In case of serious misalignment, contact your dealer).

Warning: The ball joint socket must run parallel with the steering arm. The socket must be restrained when tightening the tie rod end lock nuts.

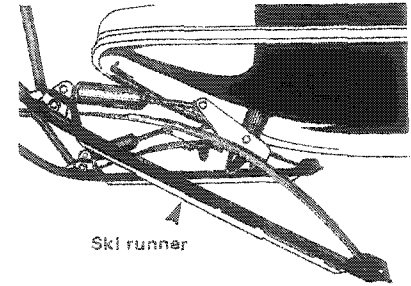
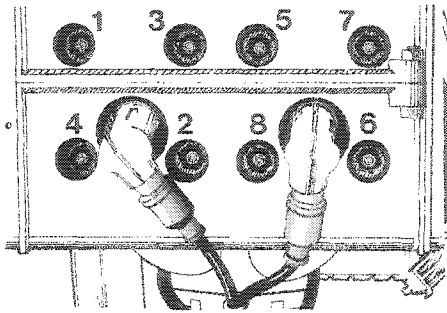

(M4) Engine Head Nuts

After the first 5 hours of operation, check that engine head nuts are tight and equally torqued (16 to 18 ft/lbs when cold).

(M5) Engine Mount Nuts

With cab tilted, check engine mount nuts for tightness. Torque to 220-275 inch/lbs.

(M6) Slider Shoe Wear

During normal driving, snow will act as a lubricant and coolant for the slider shoes. Extensive riding on ice or sanded snow, not to mention dirt, asphalt, etc. **never** recommended, may create excessive heat build up and cause premature slider shoe wear. Always inspect shoe condition and replace as necessary.

(M7) Vehicle General Inspection

Check electrical wiring and components, retighten loose connections. Check for stripped wires or damaged insulation. Thoroughly inspect the vehicle and tighten loose bolts, nuts and linkage. Inspect ski runners for wear.

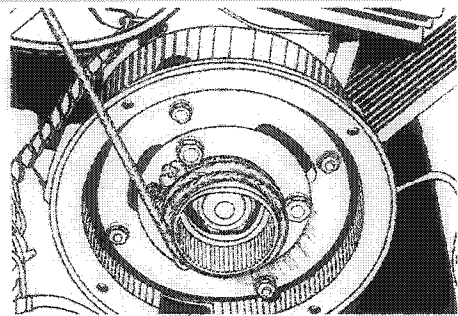
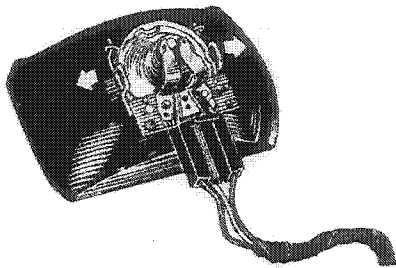

EMERGENCY GUIDE

Burnt Light Bulb

If headlamp is burnt, stop engine, unlock cab latches (2) and tilt cab. Unplug connector from headlamp. Remove rubber boot and unfasten bulb retainer clips. Detach bulb and replace. If taillight bulb is burnt, expose bulb by removing red plastic lens. To remove, unscrew the two (2) Phillips head screws.

Broken Throttle Cable

Remove throttle cable and replace. Check lever operation. If necessary replace housing.

Warning: Before starting engine, handlebar throttle lever must return swiftly to its original position. Carburetor throttle lever must also return to an idle position (butterfly closed). Do not start engine unless both are verified.

Broken Rewind Starter Rope

Abuse of the rewind starter may cause the rope to fray and break. Should this situation arise, remove starter unit using 10 mm wrench supplied in tool kit. Transfer rope grip to your emergency rope. Make a knot at the end of emergency starter rope and wind rope around starter pulley. Pull vigorously as per usual manual start. See your dealer for immediate repair or replacement of starter unit.

TROUBLE SHOOTING GUIDE

| Symptoms | Possible Causes | What To Do |
|--|--------------------------------------|---|
| Engine turns over but fails to start or starts with difficulty | 1. No fuel to the engine | Check the tank level and fill up with correct gas-oil mixture. Check for possible clogging of fuel line, item 5. |
| | 2. Spark Plug | Check for fouled or defective spark plug. Disconnect spark plug wire, unscrew plug and remove from cylinder head. Reconnect wire and ground exposed plug on engine head, being careful to hold away from spark plug hole . Follow engine starting procedure and check for spark. If no sparks appear, replace spark plug. If trouble persists, check item 3. |
| | 3. Faulty ignition | Disconnect spark plug wire from plug, unscrew the spark plug cap then position wire about 1/8" from the cylinder head. Follow engine starting procedure and if no sparks appear, it means a faulty ignition system. Do not attempt to repair. Contact your dealer. |
| | 4. Flooded engine | Disengage choke, wait 60 seconds or more then depress throttle lever fully and try to start engine. Release throttle lever immediately after engine starts. |
| | 5. Clogged fuel line (water or dirt) | Remove and clean the fuel filter. Change filter cartridge if necessary. Check condition and connections of fuel lines. Check the cleanliness of the fuel tank. |
| | 6. Faulty Carburetor | First make primary adjustments on carburetor (See Maintenance Section). If carburetor is still faulty, contact your dealer for repair. |
| | 7. Too much oil in fuel | Drain the fuel tank and refill with the correct gas/oil mixture. |
| | 8. Breaker points | Breaker points may be worn or out of adjustment. Contact your dealer. |
| | 9. Poor engine compression | Running with a lean fuel mixture may produce excessive engine wear resulting in poor engine compression. If this occurs, contact your dealer at once. |
| Engine will not turn manually | 1. Seized engine | In the case of a seized engine, contact your dealer. Seizure is a direct result of poor lubrication. |

| Symptoms | Possible Causes | What to do |
|--|--------------------------------------|---|
| Engine will not start (electric model only). Note: If failure is in starting system, engine will start manually | 1. Battery | Check condition at battery by turning lights ON. If lights are dim or out, battery may be discharged or defective. Contact your dealer. If battery is good, check item 2. |
| | 2. Poor connections | Check for loose or corroded battery or starter connections. Tighten and clean if necessary. Try to restart engine electrically. |
| | 3. Starter | If connections are tight and battery is in working order probable cause of trouble is defective starter. Contact your dealer for repair. |
| Engine lacks acceleration or power | 1. Fouled or defective spark plug | Check item 2 of "Engine turns over but fails to start or starts with difficulty". |
| | 2. Clogged fuel line (water or dirt) | Check fuel line condition. (See item 5 of "Engine turns over but fails to start or starts with difficulty"). |
| | 3. Carburetor | Readjust the carburetor. (See Maintenance Section). If trouble persists, contact your dealer. |
| | 4. Defective ignition | First check item 2 and 3 of "Engine turns over but fails to start or starts with difficulty". If the ignition system still seems defective, contact your dealer. |
| | 5. Engine | If unable to locate specific symptoms, contact your dealer. |
| Engine continually backfires | 1. Faulty spark plug | Check item 2 of "Engine turns over but fails to start or starts with difficulty". |
| | 2. Overheated | Contact your dealer. |
| | 3. Engine timing incorrectly set | Contact your dealer. |
| Snowmobile cannot reach full speed | 1. Drive belt | Check for defective or worn drive belt. Replace if necessary. |
| | 2. Incorrect track adjustment | Check track tension and alignment. Readjust to specifications. (See Maintenance Section). |
| | 3. Faulty engine | Check item 1 to 5 of "Engine lacks acceleration or power". |
| | 4. Pulley misaligned | Contact your dealer. |

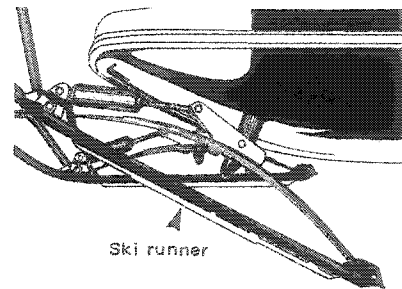
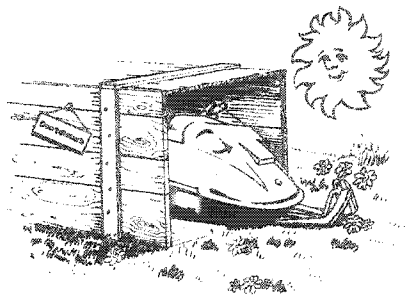

OFF SEASON STORAGE

It is during Summer, or when a vehicle is not in use for any length of time that proper storage is a necessity.

Storage of the Ski-Doo snowmobile during long periods of inactivity consists of checking and replacing missing or worn parts; Proper lubrication and treatments to insure that parts do not become rusted; Cleaning items such as carburetor of oil gas mixtures; to prevent gum varnish formation within the carburetor; and in general, preparing the vehicle so that when the time comes to use the snowmobile again it will start and be in top condition.

Important: The necessity of proper storage cannot be overstressed. If you lack the time or proper tools, see your authorized Ski-Doo Dealer.

Track

1. Inspect track for cuts, missing track inserts or broken rods and make any necessary replacement.
2. Lift rear of vehicle until track is clear of ground then support with brace or trestle. The Ski-Doo snowmobile should be stored in such a way that track does not stay in contact with cement floor or bare ground.

Note: The track should be rotated periodically, (every 40 days). Do not release track tension.

Suspension

Remove any dirt or rust. Grease idler wheels at grease fittings. Wipe off excess.

Ski Assembly

1. Wash or brush all dirt or rust accumulation from skis and springs.
2. Grease ski legs at grease fittings.
3. Check condition of ski runners. Replace if worn.
4. Apply metal protector on ski assembly. If unavailable, wipe the entire ski with cloth soaked in oil to prevent rust formation.

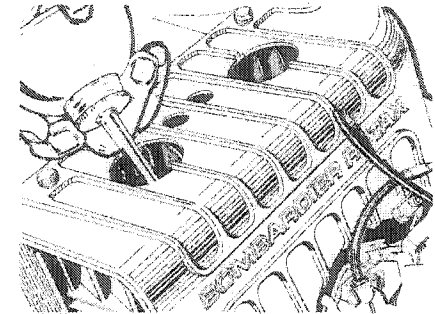
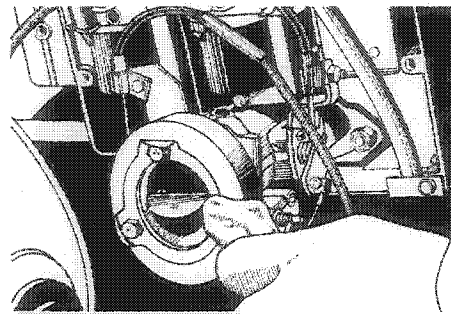

Fuel Tank

Remove cap then using a syphon, remove gasoline from tank.

Warning: Gasoline is flammable and explosive under certain conditions. Always perform procedures in a well ventilated area. Do not smoke or allow open flames or sparks in the vicinity.

Carburetor

The carburetor must be dried out completely to prevent gum formation during the storage period.

1. Assure that inlet fuel line is disconnected then start the engine and run it out of gas.
2. Remove air silencer.
3. Engage choke then pack carburetor throat with a clean piece of cloth and turn the engine a few more times. The suction should eliminate the remaining fuel.
4. Install air silencer and connect fuel line.

Cylinder Lubrication

Engine internal parts must be lubricated to protect cylinder walls from possible rust formation during the storage period.

Caution: To prevent magneto damage, make sure that the cut-out button is in the lower position.

1. Remove spark plugs.
2. Operate rewind starter to bring piston at **top** position.
3. Pour about one spoonful of oil into spark plug hole.
4. Slowly crank engine 10 to 12 times using manual starter.
5. Repeat above steps for other cylinder.
6. Install spark plugs.

Note: This operation should be repeated every 40 days during storage.

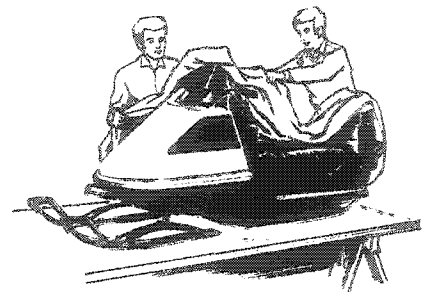
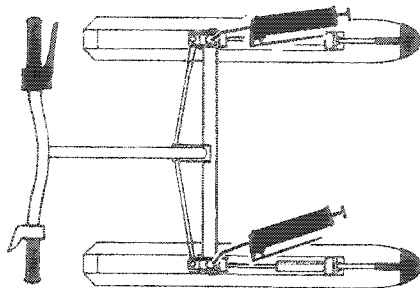

Chaincase

Drain the chaincase completely and refill with 9 ozs of fresh Ski-Doo chaincase oil. To drain, remove chaincase cover.

Controls

1. Lubricate steering mechanism. Inspect components for tightness, (spring coupler bolts, tie rods, spherical ball joints, etc.) Tighten if necessary.
2. Oil moving joints of brake mechanism.
Avoid getting oil on brake pucks.
3. Coat all electrical connections and switches with a greaseless metal protector. If unavailable, use petroleum jelly.
4. Remove drive belt during entire storage period.

Battery (Electric models only)

1. Remove battery from vehicle and clean outside surface of battery with solution of baking soda and water. Remove all de-

posits from posts then rinse with clear top water.

Caution: Do not allow cleaning solution to enter battery interior since it will destroy the electrolyte.

2. Check electrolyte level in each cell. Refill if necessary with distilled water.
3. Fully charge battery. (A stored battery should be recharged at least every 40 days).

Warning: Gases given off by a battery being charged are highly explosive. Always charge in a well ventilated area. Keep battery away from cigarettes or open flames.

4. Coat battery terminals with petroleum jelly and store unit in a cool, dry place.

Chassis

1. Clean the vehicle thoroughly, removing all dirt and grease accumulation.

Caution: Plastic alloy components such as throttle and brake levers, windshield, etc., can be cleaned using mild detergents or isopropyl alcohol. Do not use strong soaps, degreasing solvents, abrasive cleaners, paint thinners, etc. To clean the frame use only "Aluminum Cleaner"

2. Inspect cab and repair damage. Repair kits are available at your authorized Ski-Doo dealer.
3. Wax the complete cab for better protection.
4. Protect the vehicle with a Ski-Doo cover to prevent dust accumulation during storage.

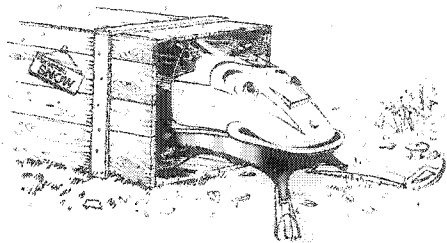

PRE-SEASON PREPARATION

Snow is falling and you are now anticipating the next snowmobile safari. If you have observed and adhered to the storage procedures outlined in this manual, your vehicle preparation becomes a relatively easy task.

To simplify the pre-season preparation we have drawn up a small check list.

Many items have been forementioned in the Lubrication or Maintenance sections of this manual therefore quick and easy reference is possible.

Again we mention, should you lack the time or tools to complete the task, to contact the Ski-Doo dealer of your choice and obtain his professional assistance.

- Spark plugs; Change.
- Chaincase; Check oil level.
- Pulleys; Clean.
- Skis; Align.
- Fuel filter; Change.
- Fuel lines; Connect then check attaching points at tank and carburetor.
- Track; Check tension and alignment.
- Drive belt; Inspect and install.
- Throttle Cable; Check for damage. Check operation.
- Brake; Inspect pucks and operation.
- Oil seals; Inspect for possible cuts or leaks.
- Battery; Test, clean and install.
- Engine timing; Replace breaker points. Set timing.
- Wiring; Check electrical wiring for broken or damaged insulation. Inspect connections.
- Manual Starter; Inspect condition of starting rope.
- Fasteners; Check tightness of all nuts, bolts and linkage. Pay particular attention to engine head nuts— 16 ft/lbs torque. Governor bolt 58-68 ft/lbs torque.
- Gas Tank; Refill.
- Carburetors; Adjust.

IMPORTANT: Observe all Warnings and Cautions mentioned throughout this manual which are pertinent to the item being checked. When component conditions seem less than satisfactory, replace with genuine Bombardier parts.

SPECIFICATIONS

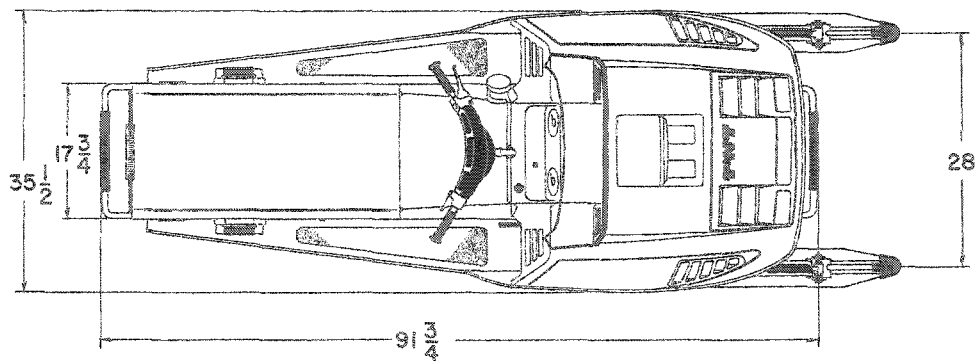
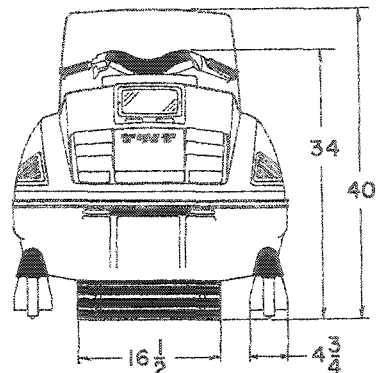
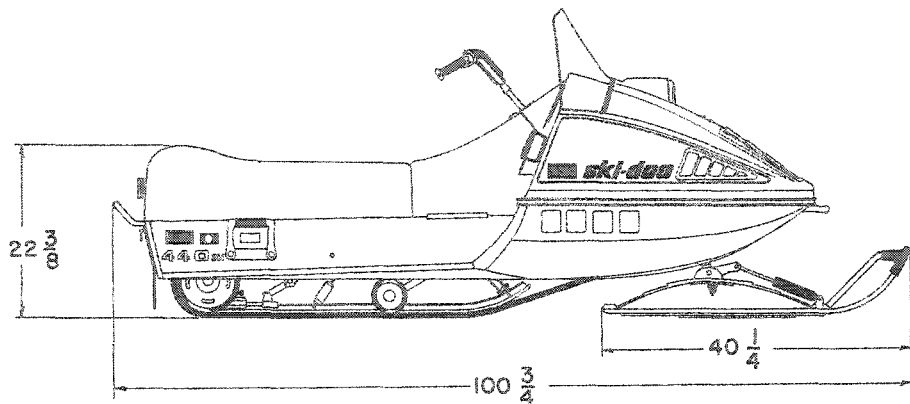

| MODEL | T'NT FAN COOL | 300 SM | 340 SM | 340 SE | 440 SM | 440 SE | EVEREST 440 SM |
|-------------------|-----------------------------------|---------------------|-------------|-------------|-------------|-------------|----------------|
| Engine | Number of cylinders | 2 | 2 | 2 | 2 | 2 | 2 |
| | Bore (m.m.) | 57 | 59.5 | 59.5 | 67.5 | 67.5 | 67.5 |
| | Stroke (m.m.) | 57.5 | 61 | 61 | 61 | 61 | 61 |
| | Displacement (c.c.) | 293.5 | 339.2 | 339.2 | 436.6 | 436.6 | 436.6 |
| | Compression ratio | 11.8:1 | 11.3:1 | 11.3:1 | 11.5:1 | 11.5:1 | 11.5:1 |
| | Carburetor (Tillotson) | 1XHR | 1XHD | 1XHD | 1XHD | 1XHD | 1XHD |
| | Starting | Manual | Manual | Electric | Manual | Electric | Manual |
| Chassis | Overall Length | 100 3/4" | 100 3/4" | 100 3/4" | 100 3/4" | 100 3/4" | 105 3/4" |
| | Overall Width | 35 1/2" | 35 1/2" | 35 1/2" | 35 1/2" | 35 1/2" | 35 1/2" |
| | Height | 40" | 40" | 40" | 40" | 40" | 42" |
| | Height w/o Windshield | 34" | 34" | 34" | 34" | 34" | 34" |
| | Weight (lbs.) | 350 | 360 | 390 | 375 | 405 | 390 |
| | Bearing Area | 1165 | 1165 | 1165 | 1165 | 1165 | 1247 |
| | Ground Pressure (P.S.I.) | .300 | .309 | .335 | .322 | .348 | .311 |
| Power Train | Track Width | 16 1/2" | 16 1/2" | 16 1/2" | 16 1/2" | 16 1/2" | 16 1/2" |
| | Drive Chain (pitch) | 3/8"double | 3/8"double | 3/8"double | 3/8"triple | 3/8"triple | 3/8"triple |
| Electrical System | Lighting System (output) | 55/18W. | 100W. | 100W. | 100W. | 100W. | 100W. |
| | Headlamp (Watt) | 35/35 | 60/60 | 60/60 | 60/60 | 60/60 | 60/60 |
| | Tail/stop Light (Watt) | 5/18 | 8/23 | 8/23 | 8/23 | 8/23 | 8/23 |
| Electrical System | Spark Plug (Bosch) | W-260-T-1 | W-260-T-1 | W-260-T-1 | M-260-MZ-1 | M-260-MZ-1 | M-260-MZ-1 |
| | Spark Plug Gap | .014"-.018" | .014"-.018" | .014"-.018" | .014"-.018" | .014"-.018" | .014"-.018" |
| | Advanced Ignition Timing (indir.) | .087"-.110" | .135"-.159" | .135"-.159" | .135"-.159" | .135"-.159" | .135"-.159" |
| Fuel | Tank capacity | U.S. | 7.5 gals. | 7.5 gals. | 7.5 gals. | 7.5 gals. | 7.5 gals. |
| | | Imp. | 6 gals. | 6 gals. | 6 gals. | 6 gals. | 6 gals. |
| | Gasoline | Premium | Premium | Premium | Premium | Premium | Premium |
| | Gas/oil ratio | 50/1 | 50/1 | 50/1 | 50/1 | 50/1 | 50/1 |
| Brake | Type | Disc self-adjusting | | | | | |

All information, illustration and component/system description, contained in this manual are correct at the time of publication. However, Bombardier Limited reserves the right to make changes in design and specifications, and/or to make additions to, or improvements in its product without imposing any obligations upon itself to install them on its products previously manufactured.

1974 SKI-DOO* WARRANTY

Bombardier Limited (Bombardier) as manufacturer, warrants every 1974 Ski-Doo® snowmobile, (except T'NT F/A), Ski-Boose® or Carry-Boose® tow sled, SOLD AS A NEW VEHICLE BY AN AUTHORIZED SKI-DOO DEALER, to be free from defects in material, and workmanship under normal use and service, for a period of 12 consecutive months from first date of sale. If defective, repair and/or replacement is valid only at an authorized dealer in Canada or in the United States.

CONDITIONS

- Proof of ownership submitted to the servicing dealer, by means of the Ski-Doo service card.
- Proper maintenance; to be performed at owner's expense.

Guidelines for proper use and maintenance are detailed in each owner's manual.

EXCLUSIONS: Non-warrantable

- Variable speed drive belt, windshield filters, ignition breaker points, condensers, spark plugs, light bulbs, protective lenses, brake linings, ski runner shoes, slider shoes on suspension and variable speed pulleys, fasteners, labels, soft trim, appearance items, lubricants and paints and all tune ups and adjustments required.
- Repairs resulting from installation of parts other than genuine Bombardier parts.

- Blizzard models and any vehicle used for racing purpose.
- Any losses incurred to the vehicle owner other than parts and labour.

This warranty is expressly in lieu of all other expressed or implied warranties of Bombardier, its distributors and the selling dealer, including any implied warranty of merchantability of fitness for any particular purpose. Neither Bombardier, its distributors nor the selling dealer shall be responsible, under any circumstances, for any loss or damage as a result of hidden defects, accidents, misuses or other faults.

Neither the distributor, the selling dealer nor any other person has been authorized to make any affirmation, representation or warranty other than those contained in this warranty and if made, such affirmation, representation or warranty shall not be enforceable against Bombardier or any other person.

January 1973
BOMBARDIER LIMITED
Valcourt, Québec, Canada.

Important: Off-season storage and pre-season preparation are at the discretion and expense of the owner. However, any failure which occurs as a result of inadequate seasonal preparation shall not be covered under warranty.

SKI-DOO * SHOP MANUALS

1972

Over two hundred pages of up-to-date information on Repairs and Servicing Completely illustrated. Everything you'll ever need to know about servicing your 1972 Ski-Doo snowmobile.

1973

Supplement edition of the '72 Shop Manual. Includes the latest design changes and servicing techniques for '73 vehicles.

1974

Complete step by step procedures for vehicle repair. Illustrated. Covers 1974 vehicles. Also included adjustment data on vehicles built '63 through '74.

Reserve your copy now! Send certified cheque or money order to:

Canada

Bombardier Limited,
Technical Information Centre,
Valcourt, Québec
Canada

U.S.A.

Bombardier East Inc.,
Railroad Street,
Lee, Massachusetts. 01238

To be completed and returned with
a money order or a certified cheque

NAME _____

(BLOCK LETTERS)

STREET _____

CITY _____

STATE / PROV. _____

ZIP CODE _____

SEND ME _____

1972 SHOP MANUAL \$7.95

1973 SUPPLEMENT \$5.00

1974 SHOP MANUAL \$8.95

*Trademark Bombardier Limited

NOTE: In the event of change of ownership, complete the notice of transfer form below in order to qualify the new owner for balance of warranty. All such transfers should be reported to an authorized Ski-Doo dealer for modification of the Ski-Doo Service Card. In the event of a lost Service Card, contact the original selling dealer for completion of the "Request for New Service Card" form. For a \$2.00 handling charge, Bombardier will mail your new personalized Service Card to you.

**Bombardier Limited,
Valcourt, Québec, Canada.**

NOTICE OF TRANSFER

Model Vehicle Serial No.
The ownership of this vehicle is transferred
From

Signature of registered owner

To
Full name of purchaser *Block letters*

Address _____
No Street or Village

City County
Date

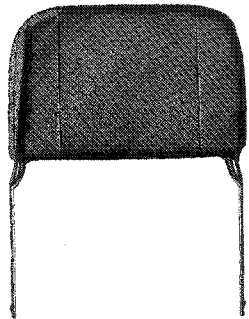

Backrest

- Easily installed on Ski-Doo® snowmobiles.
- Can be attached at two locations—center for driver only rear for passenger.
- Attractive sturdy leatherette and metal construction also available chrome coated.
- Highly recommendable for all snowmobiles carrying more than one passenger.

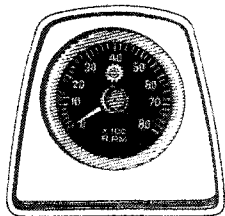

Tachometer

The tachometer registers the impulses of the magneto. Direct-reading dial indicates (in thousands) the number of revolutions per minute (R.P.M.) of the engine. Vital towards maximum performance and engine diagnosis.

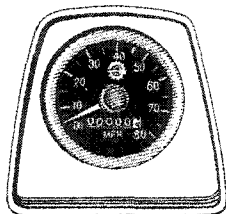

Speedometer

Linked directly to the drive axle. Direct-reading dial indicates the speed of the vehicle in miles per hour (M.P.H.). 6 digit Odometer records the number of miles travelled.

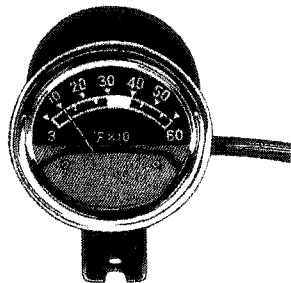

Temperature Gauge

Developed for observing changes in cylinder head temperatures. Features: high sensitivity . . . quick response . . . special heat compensating bi-metal . . . internal illumination and quick connect pick-up unit. Applicable to all models.



Snow Guard

- Prevents snow from blinding trailing snowmobilers.
- Strong thick rubber ensures long lasting durability.
- Perfectly flexible even under extreme cold.
- A must for all racing snowmobiles and an added precaution for snowmobilers on safari.
- Applicable to all models.

All genuine Ski-Doo parts and accessories are specifically designed to provide you with peak performance. Whether it's for comfort or safety, you know that you can depend on genuine Ski-Doo parts and accessories available only at Ski-Doo dealers across the country.

. . . and the Bombardier corporation is behind them all.

*Registered Trademark of Bombardier Limited

Suggested Retail Price \$1.00

(First copy free with unit purchased)